

MSB-RS485-PLUS RS422/485 Protocol Analyzer

Sample rate
up to 200 MHz

Time resolution
10 Nanoseconds



"The perfect combination of sophisticated hardware and software analysis"

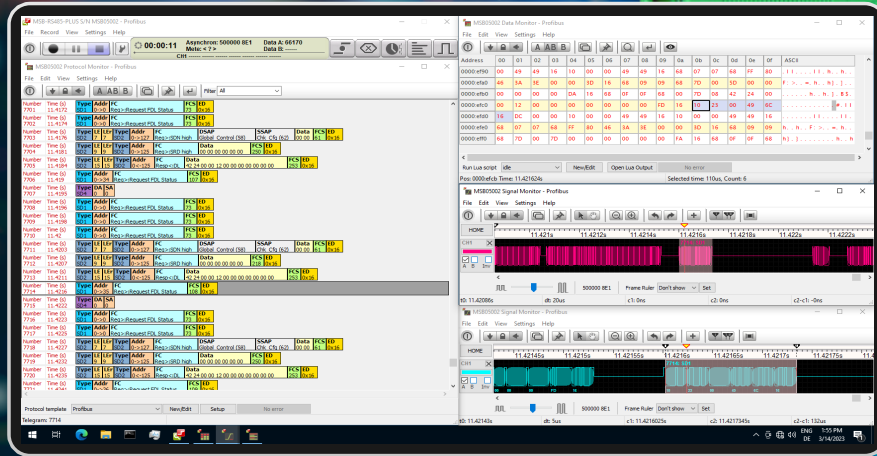

recording • exploring • visualizing



An essential tool for RS422/485 analysis/optimizing

As an autonomous device the analyzer gathers exact information about every line change with 10 nanosecond precision, independent from the PC and its operating system and mandatory for time relevant protocols like Modbus RTU, Profibus and many others. Two special inhouse developed serial input channels take over the task of data decoding either for asynchronous or synchronous protocols like SSI and Manchester. And a unique segment mode let you detect the data direction even with 2-wire bus systems.

Equipped with a multitude of visualization tools showing the different OSI layers it allows a detailed view of every transmission layer in a RS422/RS485 communication and detects errors coming from bus enabling, timeouts or wrong respectively double addressing.

Due to its high adaptable protocol template mechanism based on the Lua script language the analyzer is not only able to visualize telegrams of common field busses - it is recommended especially for all kind of individual or closed/proprietary protocols.

Multiple connection modes allow the complete logging of all bus activities as well as the purposeful recording of data sent from selected bus participants. Two additional auxiliary in/outputs serve for the correlation to further application signals (data frame/error triggering and more).

Run it on your favorite OS - It's your choice! Supports Windows and Linux
Multi-language - Software in English and German



Product Features

The unerring eye into your transmission

- OS independent real time resolution of 10 nanoseconds
- Detects undriven signal levels (tri-state)
- Shows the correct time relationship between all lines and data
- Display the real logic changes of the two data signals
- Bus splitting allows separated watching of certain bus participants

Prepared for the unexpected

- Supports any bit rate from 1 Bps to 20 MBps
- Automatic detection of bit rate (synchron, asynchron), databits and parity
- Supports protocols with 9 data bits
- Detects breaks and bus faults
- Individual protocols through highly adaptable templates and Lua
- Supports synchronous SSI and Manchester transmission
- Very adaptable through switchable bus terminators and data inverting

Autonomous USB device

- Independent analyzer box, controlled and sourced via USB
- Fast real-time signal/data processing realized in hardware
- Easily adaptable to various bus systems
- Data and telegram recording with direction recognition
- Automatic time stamping and event generation
- One LED per channel to show the current bus state dynamically
- Data transfer to unlimited PC storage facilities
- Updatable firmware for future-proof extensions or improvements

IFTOOLS GmbH
Matterhornstrasse 17
65199 Wiesbaden
Germany

www.iftools.com
Email: info@iftools.com
Fon: +49 611 7237389-3/4

We ♥ quality
 Made
 In
 Germany

Technical changes and improvements can be done without prior notice

Page 1
January 2024

Analyzer software with unique MultiView concept

When analyzing data transmissions you often have to switch between several protocol layers, in case you want to see the raw data bytes behind a telegram or the logical tri-state signal forming the bytes. More than that: You need to compare different transmission parts, check the time response amid telegrams and simultaneously look for the signal relationship.

The answer - The MultiView concept

The analyzer program uses a multi-process architecture for stability and scalability. It draws a clear distinction between the recording and real-time displaying of data or signal. Even though working like a single application, the software delegates the display part to modular 'View' programs, each one specially designed and highly adapted to its protocol layer or particular task. There are Views for:

- Showing the telegram (**ProtocolView**)
- Displaying the raw (also 9-bit) data (**DataView**)
- Plotting the logical tri-state signal (**SignalView**)
- Monitoring all occurring events (**EventView**)

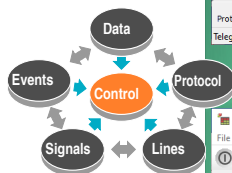

Already while recording you can open as many Views as you want and assign them to certain parts of the current or stored recording.

Views can act independently or in step with others. They update their content depending on the selection/click in another view, or just display the currently received data.

You can resize and place them on your screen(s) according to your wishes without disturbing an active recording!

Easy to use

Every View follows the concept to offer a specially optimized display and toolbox for its kind of examination. Gone are multiline toolbars and overloaded menus.

The **ProtocolView** stands on top of the transmission layers and splits the data stream into a given protocol like ModBus, ProfiBus etc. You can modify the protocol specifications in real-time to check how the telegrams come up with different settings.

The **DataView** shows you the received data including direction, framing, parity or break informations. It scores with a powerful search engine using regular expressions to find special sequences or data patterns.

The **SignalView** acts like a digital scope. You can zoom in and out, measure signal distances with two cursors, validate data frames and parities, check the logical signal levels or look for a jittering bit rate.

The **EventView** isn't associated with a protocol layer and monitoring all kind of events. It is especially useful when you are searching for level changes, a given level duration, bus states or bus errors.

Various export and data sharing abilities

let you further evaluate all recorded data in spreadsheet programs like Excel® or Calc® and make it easy to document the analysis results in most text processing applications.

MSB-RS485-PLUS RS422/485 Protocol Analyzer



Protocol display
extremely adaptable
by integrated Lua 5.3



Lua powered protocol templates

Equipped with a powerful Lua script engine the protocol view is able to parse all thinkable RS422 and RS485 fieldbus protocols. And together with an unique box model it allows the user to format and summarize the telegram output in an extremely wide range.

Handles all telegram definitions

The Protocol View handles the splitting of the continuous data stream into single telegrams by rules and functions, defined in the script language Lua. This makes the Protocol View widely adaptable also to very special and uncommon or even proprietary protocols. It even allows you to write your own protocol setup and filter dialogs.

Telegram definitions with an unusual EOS, a telegram with a specified length encoded as a byte at a certain position or an idle pause between every telegram like Modbus RTU or Profibus. Thanks to the integrated Lua all this is handled in a few lines.

What's more: You can play around with the protocol definition in a well equipped editor and see your modifications immediately in the display and without any affection to the recorded data.

Individual telegram output

Every telegram should be shown with certain informations: date and time, address (bus participant), function code, data (in various formats), checksum, telegram delimiter and other things which will become needful when you have to interpret or analyze a communication.

A special box output model combined with Lua makes it very easy to adapt the telegram data to your needs or write your very own telegram decoder.

Real-time display of own checksums

Don't worry about individual checksum validations! With the integrated Lua you can calculate any checksum according to your specifications and display the result right on every telegram.

Comes with many ready-to-use protocol templates

3964R	MDB/ICP	SAE-J1922
BACNet	Modbus ASCII/RTU	SMA-Net
Allen Bradley DF-1	MOVILINK	SSI
DNP3	NMEA	Smith Meter
Executive	P-NET	SRecord
IEC60870-5-101/3	Profibus	USS
Lin BUS (tbd)	SAE-J1587	9 bit protocols

and many others more general templates (STX/ETX, CR/LF, Break,...). All templates are written in Lua themselves and can be easily adapted or extended for your own purposes.

CSV and HTML telegram export

The analyzer program is well equipped for most analyzing intentions. Nevertheless there are situations when you have a need for processing the recorded data - here the telegrams - with additional tools or external applications. Therefore you can export them as:

- HTML for documentation
Simple insertion of choosen telegrams in text processing applications.
- CSV for spreadsheet applications
Processing of telegram informations e.g. in Excel for statistical analysis.

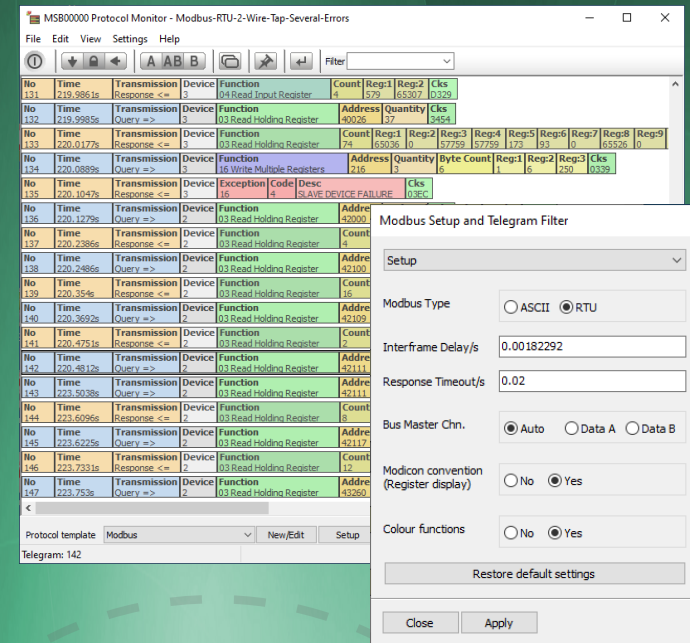

Time	Addr	Function	Quantity	Startaddr	Cks OK
0.080646s	1	ReadHolding Register	114	0	EFC5

```

box.text{ caption="Addr", text=telegram:Data(2) }
box.text{ caption="Time", text=telegram:time() }

-- a simple checksum algorithm
function checksum( from, to )
    local sum = 0
    -- add all telegram bytes from...to
    for i=from, to do
        sum = sum + tg.data( i )
    end
    -- we only need a 8 bit checksum
    return sum % 256
end
    
```

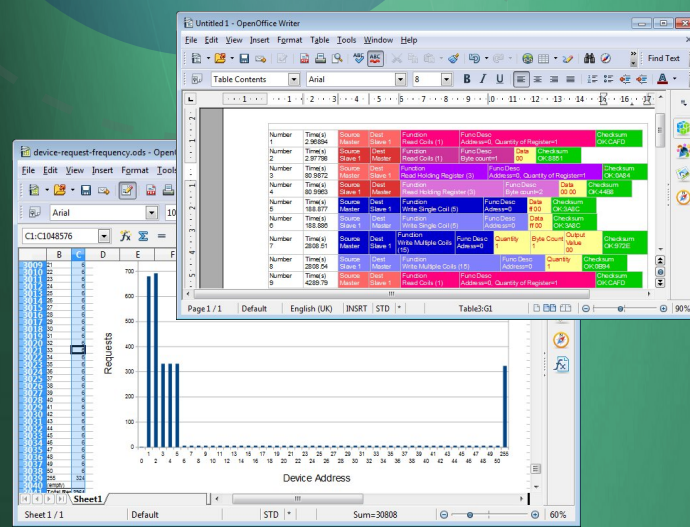

MSB-RS485-PLUS

RS422/485 Protocol Analyzer



An innovative concept for various bus connections

makes it easy to analyse different bus systems like EIA-422 point-to-point connections (with and without handshake), 2-wire half duplex EIA-485 and 4-wire full duplex bus systems. Multiple connection modes allow the complete logging of all bus activities (Plain Tapping) as well as the purposeful recording of data sent from selected bus participants (Segment Analysis).

1 Tapping 2-wire system

In this mode the analyzer records all transmitted data independent of source and direction. To get more information about the sender of the data you have to know the corresponding used protocol.

2 Tapping 4-wire system

This kind of wiring is used for point-to-point connections like EIA-422 but also used for analysis of full duplex EIA-485 connections (as DIN-Messbus, Master-Slave) if you do not need to watch a special bus device singularly and if you can assign the data to the bus participants by evaluating the protocol.

3 Tapping two 2-wire systems

The analyzer records two independent 2-wire half-duplex bus systems simultaneously, i.e. applications with a redundant bus design.

4 Segment analysis 2-wire system

The analyzer is inserted into the bus and becomes the interface between any two bus segments. The data, flowing through this interface, are collected together with their direction so that they can be clearly assigned to the corresponding segment. If the segment consists of only one bus device, the data sent from this device can be easily assigned to this device independent from the remaining bus communication - even without having to know the used protocol.

5 Segment analysis 4-wire system

Bus systems with full duplex 4-wire connection (Master-Slave bus, Din-Messbus) also use separate send and receive channels. While the master is connected as sender (Masterbus) to the receivers (Slaves) these return their answers on the second channel (Slavebus) to the master. To monitor the send data from the master a single tapping of the master bus is sufficient. In contrast the slaves share one channel to send their data back to the master. With the help of the segment analysis a singular device can intentionally be separated and its communication with the master monitored without regarding the other devices.

6 Tapping two SSI busses

Connecting the data and clock of a SSI bus the analyzer is able to record up to two independent SSI busses.

Two digital In/Outputs extend the analysis capacities

The Analyzer provides two additional digital IO-channels which can be optionally used as auxiliary inputs for recording of logic signals (either with internal pull-up or pull down) or as outputs for indication of status information like the bus data direction as well as bus validity. E.g.:

- Measuring of the reaction time between a transmitted command and an acting relays/switch.

- Triggering of an external oscilloscope by data errors. Triggering of the the beginning or end of a telegram/data frame with synchronous busses (in particular Manchester and SSI frames).

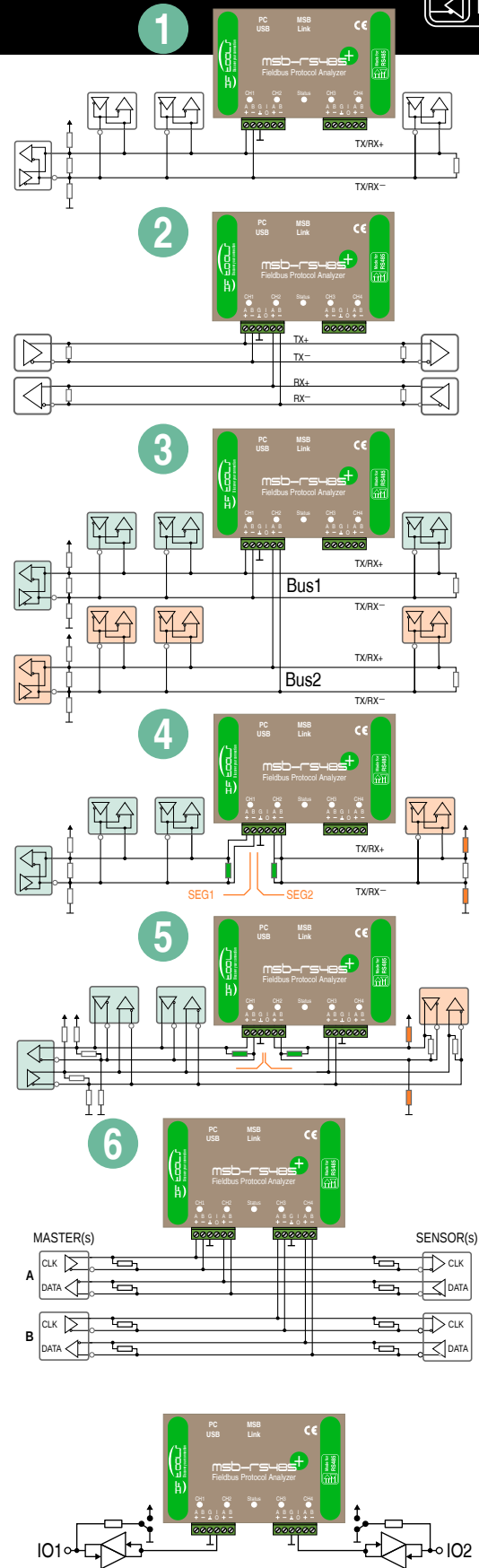

MSB-RS485-PLUS

RS422/485 Protocol Analyzer



Direct sampling and serial decoding

Precise measurement of the time relationship between data and signals is the backbone for serious protocol analysis. The direct sampling of all lines with up to 200 MSamples together with an independent decoding of the serial data, performed by two special in-house developed USART, provides:

■ 10 nsec precise and PC independent data timestamps

Essential when analyzing protocols with strict time specifications like Modbus RTU, Profibus and others.

■ Display of all logical signal levels with 10 nsec resolution

This includes also the undriven bus state and makes it easy to check for bit errors, bus faults or improper bus releases.

■ Support of any bit rate from 1 Bps to 20 MBps

Don't worry about unusual bit rates in individual applications.

■ Correct detection of the break conditions

which is an issue for reset or high level protocols using a real break as a telegram frame delimiter (e.g. sync break in a LIN or DMX512 bus).

■ Decoding of asynchron, synchron SSI and Manchester busses

No need for different tools, one device, countless use cases.

Data format scanner and 9-bit data word support

By providing its own decoding hardware for the serial transmission data the analyzer is not only able to work with uncommon bit rates but also supports 9 bit data words and comes with an unique data format scanner (bit rate, data bits, parity, Manchester and SSI parameters).

■ Detect unknown data formats (bit rate, data bits, parity)

Simply insert the analyzer in an active connection and it detects the right (a)synchronous data format and bit rate settings for you.

■ Decoding and analyzing protocols with 9-bit data

Certain bus protocols are using the parity bit as a 9th bit to differ between an address and the user data (MDB/ICP, P-NET). With the 9N1 setting you are able to turn the analyzer in a pure 9 bit recorder with full 9-bit data display and protocol support.

Synchronous recording with two or more analyzers

To compare two records the data have to be in a precise time relationship. Otherwise you cannot decide about the chronological sequence or check the synchronicity of certain events.

■ Synchronizing of multiple analyzers is simple

Just connect them with a standard network 1:1 cable and all analyzers share the same time base accuracy of 10 nanoseconds.

■ Parallel recording of different connections

Examine independent transmissions with unequal data formats, e.g. IN and OUT of a protocol converter or different bus segments.

■ Central record control by Master/Slave principle

One analyzer controls the recording. It doesn't matter if the analyzers are connected to the same or different computers.

"Direct sampling of all lines with 10nsec precision and two in-house developed USARTs ensure that you won't miss anything"

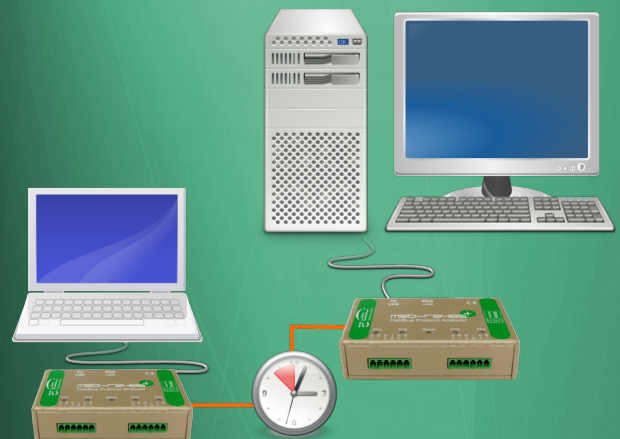
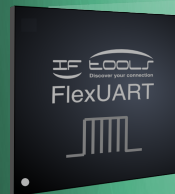
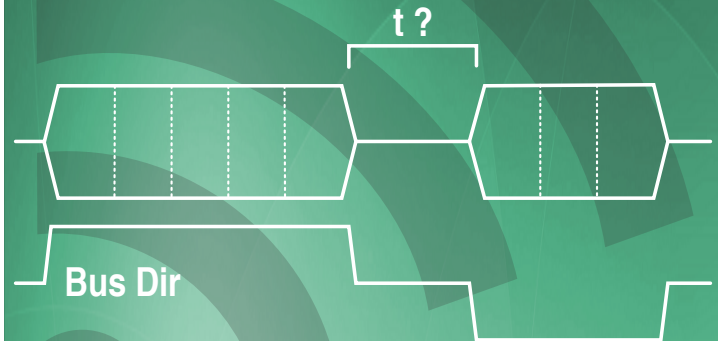

10 Nanoseconds synchron accuracy

MSB-RS485-PLUS

RS422/485 Protocol Analyzer



Download
this leaflet



Measurement

Bus Systems	Recording and analysis of asynchronous (all) and synchronous (Manchester, SSI) bus systems based on RS422/485 standard
Bit rates	High-precise setting and measuring of any bit rate from 1 Bps to 20 MBps with 0,1% precision
Asynchronous bus	5...9 Data bits, none, even, odd, mark, space parity, any stop bits and bitrates
Synchronous bus	Manchester I, II, differential Manchester T0, T1 and SSI
Logical Linestates	Detection of the logical states (A-B): 1 (V+), 0 (V-), undriven (-0.7V < In < +0.7V).
Time resolution	Detection of all line changes with 10 nanosec precision, hardware based and OS independent (sample rate up to 200 MHz). Several analyzers synchronizable.
Auto Data direction	Detection of data direction also with half-duplex (2-wire) systems, bus splitting for separate watching of certain bus participants

Connectivity

Signal levels	Standard RS422/485 Levels -7V to +12 V, ESD protected inputs 12kOhm, Common Mode ±7V. Detection of the Tri-State level of difference signals below ±0.7V
Bus connectors	Connector: 2x Phoenix MC 1,5/6ST-3,81 with 2mm screw connectors, 6 pins each. All connectors are linked through high speed and via software switchable RS485 buffers
Bus termination	120Ω bus termination individual switchable via software
Auxiliary In/Outputs	Two additional terminals individual switchable as input (0-5V, trigger level 1.65V, 10kΩ pull up or down) or output (configurable as auxiliary power 0/5V, ca. 10mA, data error or data frame signal).
Device-PC Power supply	Power supply and data connection via USB 2.0 high speed Supply through USB, ca 200mA

Recording

Principle	The analyzer marks every event (data byte, signal alternation) with a time stamp in 10 nanoseconds resolution (independent of the PC) and sends the information via USB to the connected PC where it is stored in a special file.
Featuring	Real time analyzing and simultaneous access/display of different record parts and OSI layers even during an active recording.
Capacity	4 GByte max. record file size on PC for real time analyzing. Unlimited (resp. limited by the free hard disk space) records when using the special command line API for long time recordings.
Record time	The record time depends on the selected kind of events and data rate of the connection.

Protocols

Ready to use	Includes templates for 3964(R), BACNet, DF1, DNP3, IEC60870, MDB/ICP, Modbus, MOVILINK, NMEA, P-Net, Profibus, SAE-J1587, SAE-J1922, Smith Meter, SMA-Net, SSI, USS, 9-Bit and more. Templates are continuously extended by free software updates.
Write your own	Equipped with a Lua script engine the Analyzer is able to parse all thinkable RS485 fieldbus protocols and format and summarize the telegram output in an extremely wide range.

Requirements & Supported OS

Hardware	A graphic display with minimum 1024 x 768 resolution and 16 Bit colour or better recommended, 200 MByte free hard disk space for installation, additional space for further record files. 256 MByte RAM or more, one free USB 2.0 port.
Microsoft Windows	Windows XP, Vista, 7, 8, 10, 11, all 32 and 64 bit.
Linux	All Linux with kernel 2.4.18 or higher, GLIBC 2.4 or higher and installed Gtk2 libs, 32 and 64 bit systems.

What you get

Content	MSB-RS485 analyzer, CDROM with installer for Windows and Linux. USB cable for connection to PC. 2x 6-pin Phoenix screw connectors incl. suitable screw driver
Warranty	Made in Germany, 3 years warranty and free product lifetime updates for firmware and software.

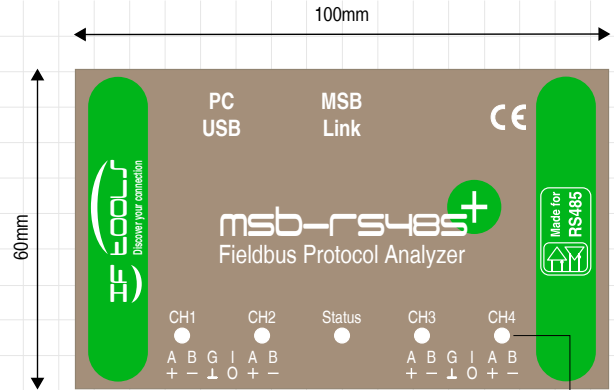

6-pin Phoenix screw connector for easy adaptable bus connection

Five Multi-colour Leds for displaying of recording and channel/bus state

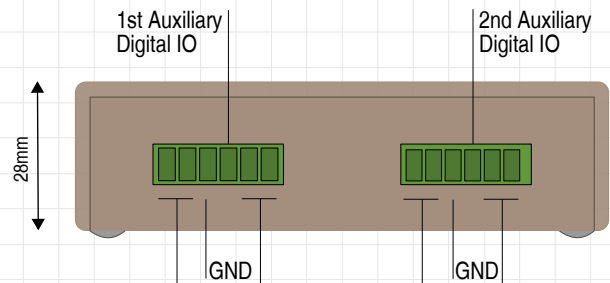

Four RS422/485 input channels with two adaptable data decoding assignments, see page bus-wiring

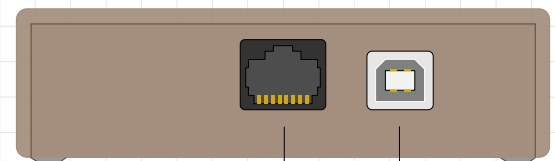

RJ45 socket to synchronize several analyzers with a resolution of 10 Nanosec

USB Type B socket for PC connection and power supply

Price: 479 € without tax

*Don't miss anything when you are going to analyse RS422/485 connections!
All necessary tools in a small case and with a special price!*



MSB-RS485-PLUS ✓ • **ISO485-BOX** ✓ • **CleverTerm** ✓

The perfect tool collection

when analyzing RS422/485 field-bus applications. Simulating telegrams or sending data sequences with the help of the USB to RS422/485 converter and the enclosed CleverTerm field-bus terminal program. Validating the correctness of requests or responses with the MSB-RS485-PLUS analyzer and detecting possible sources of errors.

MSB-RS485-PLUS Analyzer

The sophisticated MSB-RS485-PLUS analyzer not only samples all data, signals and bus-states of two half-duplex or one full-duplex connections with 10 nanosecond precision. With the help of its unique segment mode it can also act as an interface between two bus sections and detects the telegram sender or direction independent of the protocol.

ISO485-BOX Converter

The ISO485-BOX converter is equally appropriate for RS485 and RS422 bus systems. It provides high protection by its isolating features and let you feed data into a RS422/485 bus system with up to 3 MBps. Working on a RS485 bi-directional bus system the converter activates the bus when sending data and releases it again afterwards. This is handled completely transparent and automatic by the converter.

A modern designed case

keeps your tools safe wherever you are.

Run it on your favorite OS - It's your choice!
Supports Windows and Linux



In the box

MSB-RS485-PLUS serial analyzer set

- MSB-RS485-PLUS fieldbus protocol analyzer
- Protocol templates for all common field-bus protocols
- Unique segment mode and sophisticated Protocol analysis.
- The ability to analyse both, synchronous and asynchronous systems
- Lifelong software updates and support

Isolated ISO485-BOX USB to RS422/485 converter

- Converter with high isolating strength and automatic send activation
- Data rate up to 3 MBps, provides non-standard bit rates
- Externally selectable operating modes (full and half-duplex)
- Selectable termination resistors and echo mode
- Designed for more than 32 bus participants

CDROM with software and special tools

- Analyzer software, drivers, manuals for Windows and Linux
- CleverTerm software and extended Lua interpreter for use with ISO485-BOX converter

Connection kit

- 2x USB Cable to connect the analyzer and converter with your PC
- 4x 6-pin Phoenix screw connectors and screw driver for the bus



MSB-RS485-PLUS Analyzer

Bus Systems	Recording and analysis of asynchronous (all) and synchronous (Manchester, SSI) bus systems based on RS422/485 standard
Bit rates	High-precise setting and measuring of any bit rate from 1 bps to 20 Mbps with 0,1% precision
Asynchronous bus	5...9 Data bits, none, even, odd, mark, space parity, any stop bits
Synchronous bus	Manchester I, II, differential Manchester T0, T1 and SSI
Logical Linestates	Detection of the logical states (A-B): 1 (V+), 0 (V-), undriven tri-state (-0.7V < In < +0.7V).
Time resolution	10 nanoseconds (hardware based) for all data and line change events
Auto Data direction	Detection of data direction also with half-duplex (2-wire) systems, bus splitting for separate watching of certain bus participants
Signal levels	Standard RS422/485 Levels -7V to +12 V, ESD protected inputs 12kOhm, Common Mode ±7V. Detection of the Tri-State level of difference signals below ±0.7V
Bus connectors	Connector: 2x Phoenix MC 1,5/6ST-3,81 with 2mm screw connectors, 6 pins each. All connectors are linked through high speed and via software switchable RS485 buffers
Bus termination	120Ω bus termination individual switchable via software
Auxiliary In/Outputs	Two additional terminals individual switchable as input (0-5V, trigger level 1.65V, 10kΩ pull up or down) or output (configurable as auxiliary power 0/5V, ca. 10mA, data error or data frame signal).
Device-PC	Power supply (200mA) and data connection via USB 2.0 high speed



Click/scan for full leaflet
MSB-RS485-PLUS

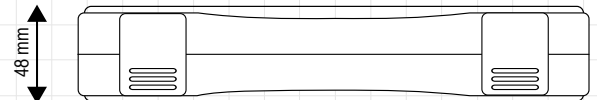
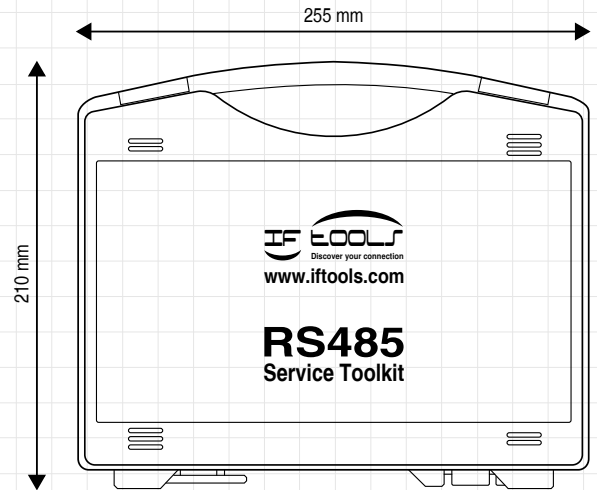

ISO485-BOX USB to RS422/485 Converter

RS422/485 Signals	TD, RD according to RS485 Standard, ±15kV ESD, ±5V difference voltage
Isolation	Isolation strength 2KVdc 1sec
Data rates	Bit rates 300 bps up to 1 Mbps, also non-standard bit rates. Additional support of the higher rates: 1.5 Mbps, 2 Mbps, 3 Mbps
Data format	All protocols with 5, 6, 7 or 8 Data bits, 1 or 2 Stop Bits and None, Even, Odd, Mark, Space Parity
Handshake	Feed back of the signals RTS/CTS and DTR/DSR in input and output for protocol simulation
Operation modes	External dip switches to easily setup all operation modes
Connectors	Bus side: 6 pin plug with screw terminal Phoenix MC156ST381
Auxiliary Voltage	Auxiliary secondary voltage output 5V/200mA to supply external devices or special bus terminations. Short-circuit proof, connected to the RS485 supply
PC connection	USB type B socket for PC connection and power supply, USB 1.1/2.0



Click/scan for full leaflet
ISO485-BOX

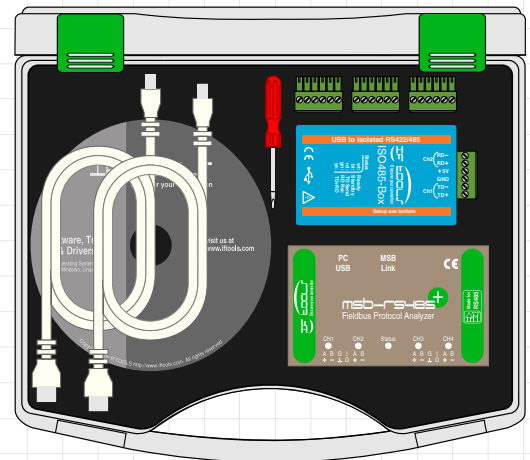

Accessories

Screw connectors	Four 6-pin Phoenix screw connectors with screw driver to easily connect the analyzer and Converter with various bus systems
Software & Manual	CDROM with software, 400 page manual as pdf, Windows ® driver and additional tools, laminated quickstart guide
USB cable	Two USB cable, 2m to connect analyzer and converter with PC

Plastic case

Material	The case consists of strong and cold resistant Polypropylene (PP), one of the environmentally friendliest plastics
Locks & Hinges	Two functional clasp prevent your case opening inopportunely and sturdy hinges ensure high stability
Dimension & weight	255 x 210 x 48 mm (B x H x D), weight about 640g with content

Our Price: 579 € *
Your advantage: ca. 60 €
 in comparison with the single components! * Without tax