

MSB-RS232-PLUS RS232 Protocol Analyzer

Sample rate
up to 200 MHz

Time resolution
10 Nanoseconds



"The perfect combination of sophisticated hardware and software analysis"

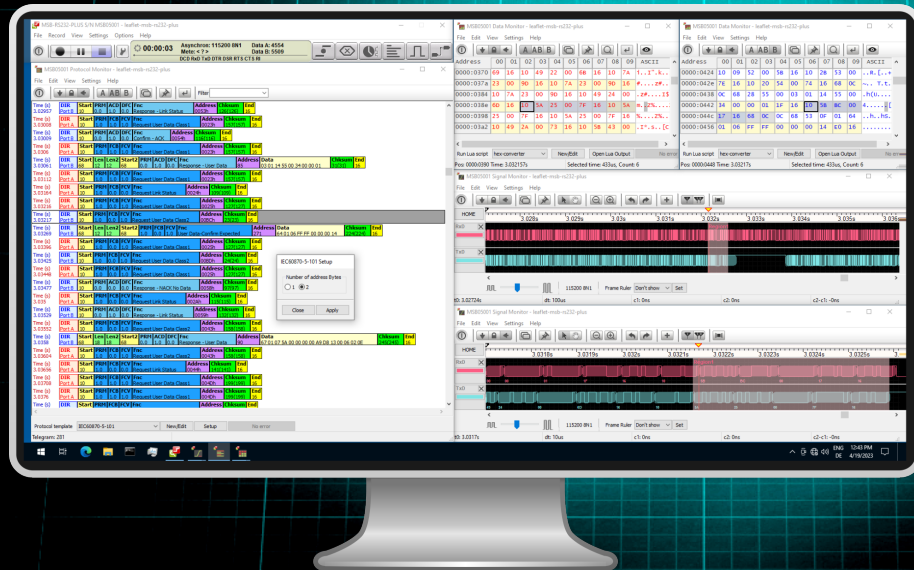

recording • exploring • visualizing



USS SSI 3964(R)...

An essential tool for RS232 analysis/optimizing

As an autonomous device the analyzer gathers exact information about every line change with 10 nanoseconds precision, independent from the PC and its operating system and mandatory for all time relevant protocols like Modbus RTU, USS or many others. Two special inhouse developed serial input channels driven by a sample rate up to 200 MHz take over the task of data decoding either for all kind of asynchronous as also synchronous SSI transmission.

Equipped with a multitude of visualization tools the analyzer allows a detailed view of every transmission layer in a RS232 communication. It detects errors coming from incorrect data formats, invalid timings, erroneous bytes or telegram spacings or wrong telegram contents and/or checksums.

Due to its high adaptable protocol template mechanism based on the Lua script language the analyzer is not only able to visualize telegrams of common field busses - it is recommended especially for all kind of individual or closed/proprietary protocols and the perfect education tool.

An integrated schematic switch editor (optional) extends the analyzer even by the capability to interactively alter the signals. Lines can be switched, rerouted or even inverted. Data can be injected in any output line (inclusive simulation of framing and parity errors). Also break conditions can be sent.

Run it on your favorite OS - It's your choice! Supports Windows and Linux
Multi-language - Software in English and German



Product Features

The unerring eye into your transmission

- OS independent real time resolution of 10 nanoseconds
- Detects invalid signal levels (tri-state)
- Shows the correct time relationship between all lines
- Display the real logic changes of the TxD and RxD signals
- Handles logic signal inputs with a trigger level of 1.3V
- Integrated HW support for synchronous RS232 transmissions (SSI)

Prepared for the unexpected

- Supports any bit rate from 1 Bps to 1 MBps
- 200 MHz sample rate ensures most accurate signal and data display
- Automatic recognition of bit rate, databits and parity
- Supports protocols with 9 data bits
- Detects breaks, framing and parity errors
- Individual protocols through highly adaptable templates and Lua

Autonomous USB device

- Independent analyzer box, controlled and sourced via USB
- Fast real-time signal/data processing realized in hardware
- Easily adaptable to various bus systems
- Data and telegram recording with direction recognition
- Automatic time stamping and event generation
- Integrated smart LED tester showing connection errors & signal states
- Data transfer to unlimited PC storage facilities
- Updatable firmware for future-proof extensions or improvements

IFTOOLS GmbH
Matterhornstrasse 17
65199 Wiesbaden
Germany

www.iftools.com
Email: info@iftools.com
Fon: +49 611 7237389-3/4

We ♥ quality
Made In Germany

Technical changes and improvements can be done without prior notice

Page 1
January 2024

Analyzer software with unique MultiView concept

When analyzing data transmissions you often have to switch between several protocol layers, in case you want to see the raw data bytes behind a telegram or the logical tri-state signal forming the bytes. More than that: You need to compare different transmission parts, check the time response amid telegrams and simultaneously look for the signal relationship.

The answer - The MultiView concept

The analyzer program uses a multi-process architecture for stability and scalability. It draws a clear distinction between the recording and real-time displaying of data or signal. Even though working like a single application, the software delegates the display part to modular 'View' programs, each one specially designed and highly adapted to its protocol layer or particular task. There are Views for:

- Showing the telegram (**ProtocolView**)
- Displaying the raw (also 9-bit) data (**DataView**)
- Plotting the logical tri-state signal (**SignalView**)
- Monitoring all occurring events (**EventView**)

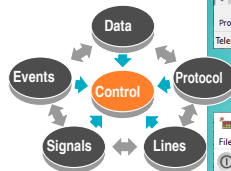

Already while recording you can open as many Views as you want and assign them to certain parts of the current or stored recording.

Views can act independently or in step with others. They update their content depending on the selection/click in another view, or just display the currently received data.

You can resize and place them on your screen(s) according to your wishes without disturbing an active recording!

Easy to use

Every View follows the concept to offer a specially optimized display and toolbox for its kind of examination. Gone are multiline toolbars and overloaded menus.

The **ProtocolView** stands on top of the transmission layers and splits the data stream into a given protocol like ModBus, USS, 3964(R) etc. You can modify the protocol specifications in real-time to check how the telegrams come up with different settings.

The **DataView** shows you the received data including direction, framing, parity or break informations. It scores with a powerful search engine using regular expressions to find special sequences or data patterns.

The **SignalView** acts like a digital scope. You can zoom in and out, measure signal distances with two cursors, validate data frames and parities, check the logical signal levels or look for a jittering baud rate.

The **EventView** isn't associated with a protocol layer and monitoring all kind of events. It is especially useful when you are searching for level changes, a given level duration, bus states or bus errors.

Various export and data sharing abilities

let you further evaluate all recorded data in spreadsheet programs like Excel® or Calc® and make it easy to document the analysis results in most text processing applications.

MSB-RS232-PLUS RS232 Protocol Analyzer



Protocol display
extremely adaptable
by integrated Lua 5.3



Lua powered protocol templates

Equipped with a powerful Lua script engine the protocol view is able to parse all thinkable RS232 based protocols. And together with an unique box model it allows the user to format and summarize the telegram output in an extremely wide range.

Handles all telegram definitions

The Protocol View handles the splitting of the continuous data stream into single telegrams by rules and functions, defined in the script language Lua. This makes the Protocol View widely adaptable also to very special and uncommon or even proprietary protocols. It even allows you to write your own protocol setup and filter dialogs.

Telegram definitions with an unusual EOS, a telegram with a specified length encoded as a byte at a certain position or an idle pause between every telegram like Modbus RTU or USS. Thanks to the integrated Lua all this is handled in a few lines.

What's more: You can play around with the protocol definition in a well equipped editor and see your modifications immediately in the display and without any affection to the recorded data.

Individual telegram output

Every telegram should be shown with certain informations: date and time, address (bus participant), function code, data (in various formats), checksum, telegram delimiter and other things which will become needful when you have to interpret or analyze a communication. A special box output model combined with Lua makes it very easy to adapt the telegram data to your needs or write your very own telegram decoder.

Real-time display of own checksums

Don't worry about individual checksum validations! With the integrated Lua you can calculate any checksum according to your specifications and display the result right on every telegram.

Comes with many ready-to-use protocol templates

3964R	MDB/ICP	SAE-J1922
BACNet	Modbus ASCII/RTU	SMA-Net
Allen Bradley DF-1	MOVILINK	SSI
DNP3	NMEA	Smith Meter
Executive	P-NET	SRecord
IEC60870-5-101/3	Profibus	USS
Lin BUS (tbd)	SAE-J1587	9 bit protocols

and many others more general templates (STX/ETX, CR/LF, Break,...). All templates are written in Lua themselves and can be easily adapted or extended for your own purposes.

CSV and HTML telegram export

The analyzer program is well equipped for most analyzing intentions. Nevertheless there are situations when you have a need for processing the recorded data - here the telegrams - with additional tools or external applications. Therefore you can export them as:

- HTML for documentation
Simple insertion of choosen telegrams in text processing applications.
- CSV for spreadsheet applications
Processing of telegram informations e.g. in Excel for statistical analysis.

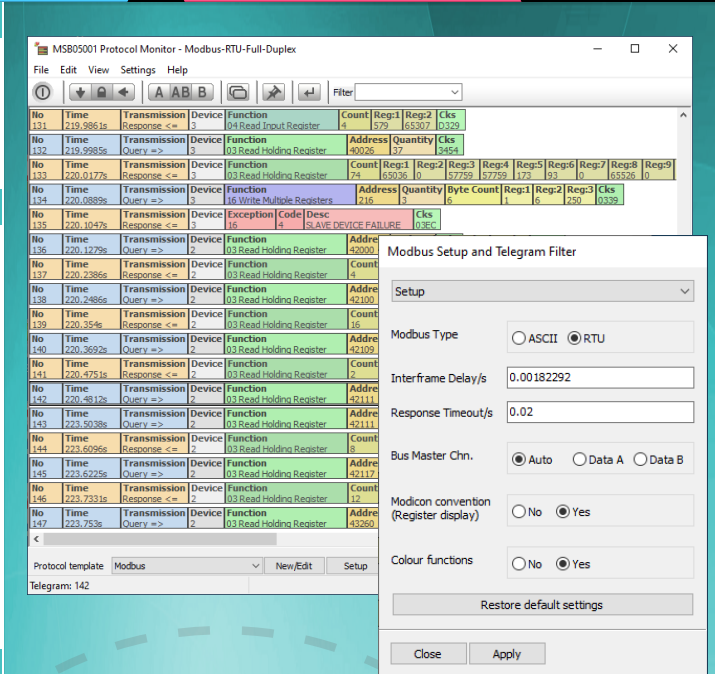

Time	Addr	Function	Quantity	Startaddr	Cks OK
0.080646s	1	ReadHolding Register	114	0	EFC5

```

box.text{ caption="Addr", text=telegram:Data(2) }
box.text{ caption="Time", text=telegram:time() }

-- a simple checksum algorithm
function checksum( from, to )
local sum = 0
-- add all telegram bytes from...to
for i=from,to do
sum = sum + tg.data( i )
end
-- we only need a 8 bit checksum
return sum % 256
end
    
```

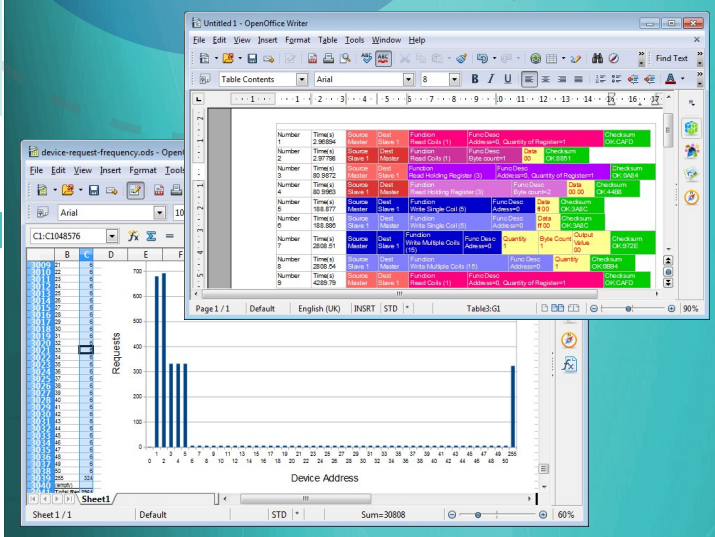

Direct sampling and serial decoding

Precise measurement of the time relationship between data and signals is the backbone for serious protocol analysis. The direct sampling of all lines with up to 200 MSamples together with an independent decoding of the serial data, performed by two special in-house developed USART, provides:

- **10 nanosec precise and PC independent data timestamps**

Essential when analyzing protocols with strict time specifications like BACnet, ccTalk, Modbus RTU, USS and others.

- **Display of all logical signal levels with 10 nanosec resolution**

200 MHz sample rate ensures most accurate display of the signal and timing even with highest bit rates. This includes also the recognition of open lines, stand-by conditions of the data drivers or short circuits.

- **Support of any bit rate from 1 Bps to 1 MBps**

Don't worry about unusual bit rates in individual applications.

- **Correct detection of the break conditions**

which is an issue for reset or high level protocols using a real break as a telegram frame delimiter (e.g. Sync Break in a LIN or DMX512 Bus) or for packet synchronization.

- **Integrated HW support for synchronous RS232 transmissions**

like SSI, no need for different tools, one device, countless use cases.

Data format scanner and 9-bit data word support

By providing its own decoding hardware for the serial transmission data the analyzer is not only able to work with uncommon bit rates but also supports 9 bit data words and comes with an unique data format scanner (bit rate, data bits, parity, synchronous SSI parameters).

- **Detect unknown data formats (bit rate, data bits, parity)**

Simply insert the analyzer in an active connection and it detects the right (a)synchronous data format and bit rate settings for you.

- **Decoding and analyzing protocols with 9-bit data**

Certain bus protocols are using the parity bit as a 9th bit to differ between an address and the user data (MDB/ICP, P-NET). With the 9N1 setting you are able to turn the analyzer in a pure 9 bit recorder with full 9-bit data display and protocol support.

Synchronous recording with two or more analyzers

To compare two records the data have to be in a precise time relationship. Otherwise you cannot decide about the chronological sequence or check the synchronicity of certain events.

- **Synchronizing of multiple analyzers is simple**

Just connect them with a standard network 1:1 cable and all analyzers share the same time base accuracy of 10 nanoseconds.

- **Parallel recording of different connections**

Examine independent transmissions with unequal data formats, e.g. IN and OUT of a protocol converter or different bus segments. are connected to the same or different computers.

- **Central record control by Master/Slave principle**

One analyzer controls the recording. It doesn't matter if the analyzers are connected to the same or different computers.

"Direct sampling of all lines with 10nsec precision and two in-house developed USARTs ensure that you won't miss anything"

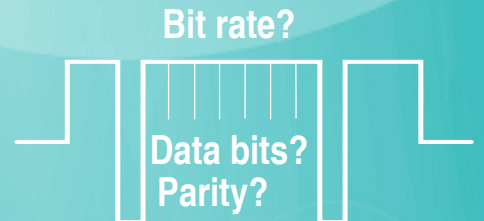
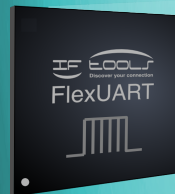
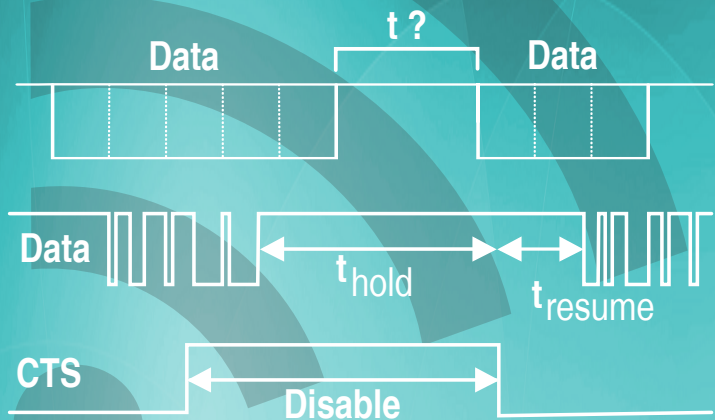

10 Nanoseconds synchron accuracy

The Switch Option - a virtual Breakout Box

The MSB-RS232-PLUS analyzer not only records all data and signals with 10 nanoseconds precision. Thanks to an integrated switch option it also let you specifically influence lines and data for testing purpose.

See how your application reacts when you switch a control line, interrupt the transmission or when you feed it with a wrong parity or a frame error.

How does it work?

Imagine the switch option as a kind of patch panel between the inputs and outputs of port A and B (similar like a breakout box). On this you can place switches, inverters and further elements and wire them to the input or output pins of both ports.

But with the difference, that you do not use real wires and switches. You only place and connect them virtually on a drawing area.

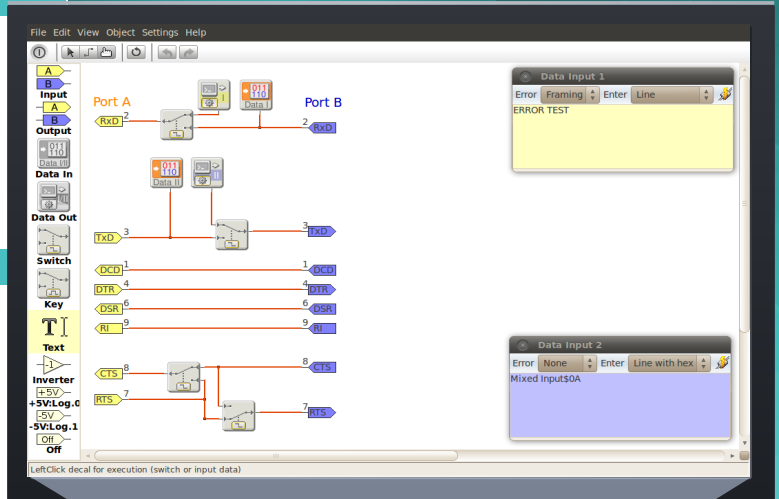

Advanced features

Additional to switch and reroute lines there are a lot of benefits, which a normal breakout box cannot provide.

Line inverting

Inverter elements allow the negation of each data or signal line.

Simulate Transmission errors and breaks

Send data together with a framing or parity error.

Data injection

Input any desired data sequences, also binaries.

Data probe of any line (UART assignment)

Free selection of lines, which are interpreted as data signal.



What's the need for?

Reroute lines and build your own adapter when uncommon lines are used. Invert signals when necessary.

Simulate/test data flow by active switching control lines. Testing the reaction on e.g. rts/cts protocols is now made easy.

Intercept and manipulate data to simulate special protocol and/or error sequences.

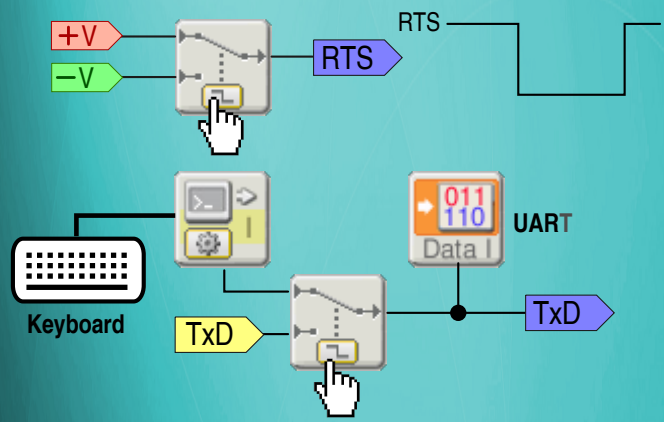
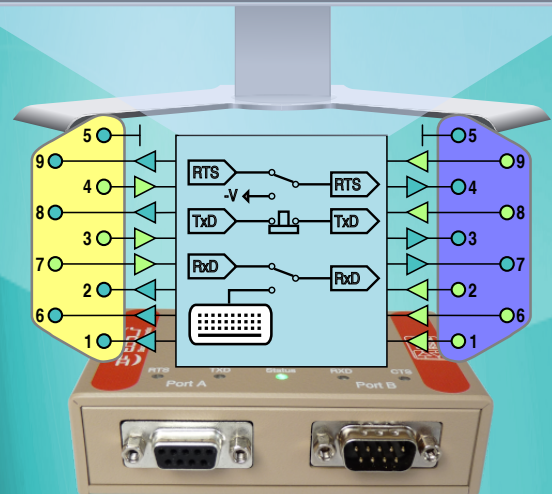

W232 Cable

Prepare your connection for non-interruptable analysis. Plug-in the analyzer at any time and without breaking or disturbing an active communication!

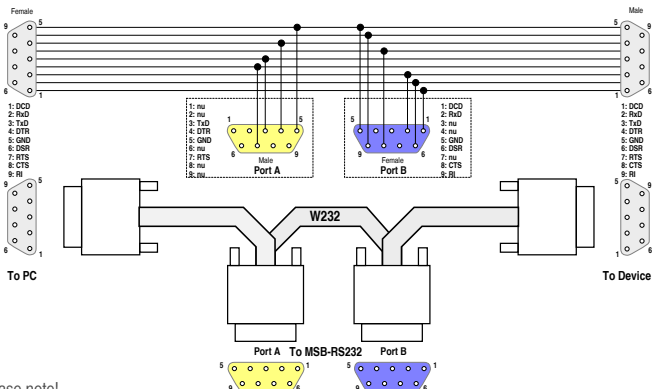

Please note!
The W232 limits the switch option capability since the outputs of the analyzer are not connected.



MSB-RS232-PLUS

RS232 Protocol Analyzer



Download
this leaflet



Measurement

Bus Systems	Recording and analysis of asynchronous (all) and synchronous (SSI) bus systems based on standard RS232 and logic signals.
Bit rates	High-precise setting and measuring of any bit rate from 1 Bps to 1 MBps with 0,1% precision .
Asynchronous bus	5...9 Data bits, none, even, odd, mark, space parity, any stop bits.
Synchronous bus	SSI with 5...63 Data bits, 1...1 MBps.
Logical Linestates	Detection of the logical states (A-B): 1 (V+), 0 (V-), invalid (-1.3V < In < +1.3V).
Time resolution	10 nanoseconds (hardware based) for all data and line change events (sample rate up to 200 MHz). Several analyzers synchronizable.

Connectors

Signal levels	Standard RS232 Levels $\pm 3V$ to $\pm 15V$, ESD protected inputs 5kOhm .
Bus connectors	Standard D-Sub 9pin connectors, male and female.
Electrical	Connection between port A and port B through high speed RS232 buffer, each switchable .
Logic Mode	All RS232 inputs adjustable as logical inputs with trigger level 1.3V, 5kOhm.
Device-PC	Power supply (200mA) and data connection via USB 2.0 high speed.

Recording

Principle	The analyzer marks every event (data byte, signal alternation) with a time stamp in 10 nanosecond resolution (independent of the PC) and sends the information via USB to the connected PC where it is stored in a special file.
Featuring	Real time analyzing and simultaneous access/display of different record parts even during an active recording.
Capacity	4 GByte max. record file size on PC for real time analyzing. Unlimited (resp. limited by the free hard disk space) records when using the special command line API for long time recordings.
Record time	The record time depends on the selected kind of events and data rate of the connection.

Protocols

Ready to use	Includes templates for 3964(R), BACNet, DF1, DNP3, IEC60870, MDB/ICP, Modbus, MOVILINK, NMEA, P-Net, Profibus, SAE-J1587, SAE-J1922, Smith Meter, SMA-Net, SSI, USS, 9-Bit and more. Templates are continuously extended by free software updates.
Write your own	Equipped with a Lua script engine the Analyzer is able to parse all thinkable RS232 based protocols and format and summarize the telegram output in an extremely wide range.

Display LEDs

USB Connection	Multi-coloured LED shows the USB/Analyzer connection and record state. Also errors caused by overload and low USB voltage.
RS232 Connection	Four multi-coloured leds act like a smart LED tester and indicate the state of the RS232 connection (correct, broken or inverted) as well as the received/sent data (even single bytes) and the RTS/CTS line states.

Requirements & Supported OS

Hardware	A graphic display with minimum 1024 x 768 resolution and 16 Bit colour or better recommended, 200 MByte free hard disk space for installation, additional space for further record files. 256 MByte RAM or more, one free USB 2.0 port.
Microsoft Windows	Windows XP, Vista, 7, 8, 10, 11, all 32 and 64 bit.
Linux	All Linux with kernel 2.4.18 or higher, GLIBC 2.4 or higher and installed Gtk2 libs, 32 and 64 bit systems.

What you get

Content	MSB-RS232-PLUS analyzer, CDROM with installer for Windows and Linux, USB cable for connection with PC, RS232 Cable, 2m, 1:1, 9Pol DSub-Connectors male to female
Warranty	Made in Germany, 3 years warranty and free product lifetime updates for firmware and software.

Optional Extensions

SwitchOption Price: 99 €	The integrated Switch Editor turns the analyzer in a breakout box and let you switch, reroute, invert lines, inject data and simulate errors just with a mouse click. See page Options.
W232-Cable Price: 39 €	The special W232 cable allows you to connect and disconnect the analyzer without interrupting the connection lines. See page Options.

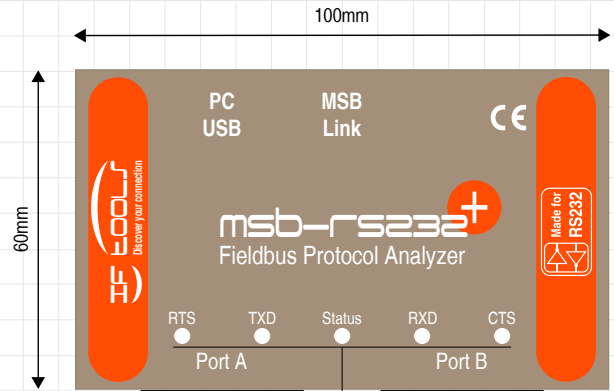

Four multi-coloured LEDs for RS232 connection state working as a smart Led tester. One multi-coloured LED indicating the device USB and operation mode

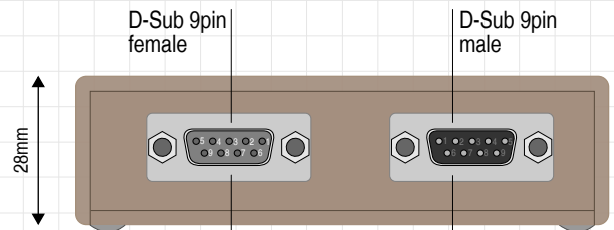

Standard D-Sub 9pin RS232 male and female connectors for simple bus connection. Interactively editable signal linkages between both ports (signal switching, inverting, rerouting, see SwitchOption)

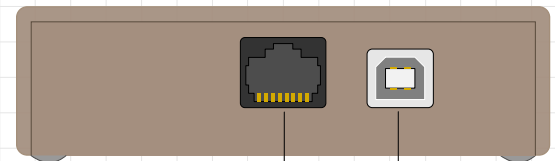

RJ45 socket to synchronizes several analyzers with a resolution of 10 Nanosec

USB Type B socket for PC connection and power supply

Price: 479 € without tax

*Don't miss anything when you are going to analyse RS232 connections!
All necessary tools in a small case and with a special price!*



MSB-RS232-PLUS • SwitchOption • W232

A trouble saving toolkit

for engineers, technicians, developer and all who install, analyse, repair and check RS232 equipments and connections. For all who like to have all needed tools ready to hand.

MSB-RS232-PLUS Analyzer + SWO

The sophisticated MSB-RS232-PLUS analyzer not only records all data and signals with a 10 nanosecond precision (up to 200 MHz sample rate). Thanks to the already integrated SWO switch option it also let you specifically influence lines and data for testing purpose.

See how your application reacts when you switch a control line, interrupt the transmission or when you feed it with a wrong parity or an frame error.

W232 Cable

Prepare your connection for non-interruptable analysis. Plug-in the analyzer at any time and without breaking or disturb a running communication!

Adapters + Gender Changers + Ledtester

Don't worry about wrong or not fitting connectors. The toolkit holds the right adapter in readiness and a Ledtester serves for quick checks.

A modern designed case

keeps your tools safe wherever you are.

Run it on your favorite OS - It's your choice!

Supports Windows and Linux



In the Box

MSB-RS232-PLUS serial analyzer set

- MSB-RS232-PLUS fieldbus protocol analyzer
- Preinstalled MSB-RS232-PLUS Switch Option SWO
- W232 connection cable for MSB-RS232-PLUS in serial or parallel mode
- USB cable to connect analyzer with PC
- CDROM with operating program, manual, tools for Windows and Linux
- Laminate Quickstart guide and RS232 Reference

Ledttester 9 Pin

- Ledttester with 25 pin connectors
- Adapter 9 pin female to 25 pin male
- Adapter 9 pin male to 25 pin female

Various Adapters and Gender Changers

- Gender Changer 9 pin male to 9 pin male
- Gender Changer 9 pin female to 9 pin female
- Nullmodem adaptor 9 pin
- Loop back plug



MSB-RS232-PLUS Analyzer

Bus Systems	Recording and analysis of asynchronous (all) and synchronous (SSI) bus systems based on standard RS232 and logic signals
Bit rates	High-precise setting and measuring of any bit rate from 1 Bps to 1 MBps with 0,1% precision
Asynchronous bus	5...9 Data bits, none, even, odd, mark, space parity, any stop bits
Synchronous bus	SSI with 5...63 Data bits, 1...1 MBps
Logical Linestates	Detection of the logical states (A-B): 1 (V+), 0 (V-), invalid (-1.3V < In < +1.3V).
Time resolution	10 nanoseconds (hardware based) for all data and line change events (sample rate up to 200 MHz). Several analyzers synchronizable.
Signal levels	Standard RS232 Levels $\pm 3V$ to $\pm 15V$, ESD protected inputs 5kOhm
Electrical	Connection between port A and port B through high speed RS232 buffer, each switchable/customizable by software (SWO)
Logic Mode	All RS232 inputs adjustable as logical inputs, trigger level 1.3V, 5kOhm
Device-PC	Power supply (200mA) and data connection via USB 2.0 high speed



Click/scan for full leaflet
MSB-RS232-PLUS

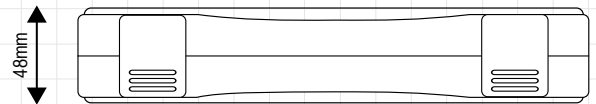
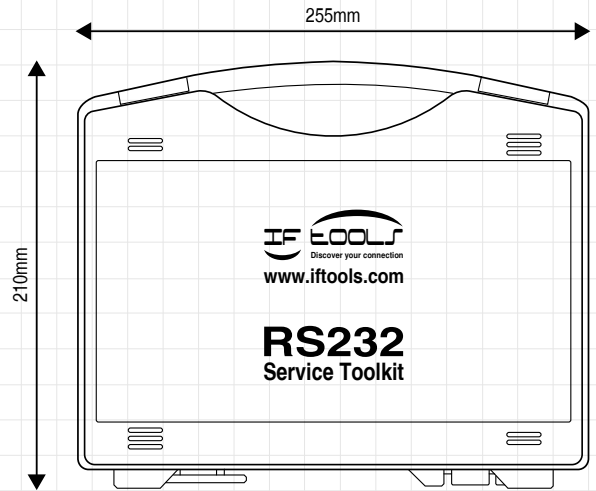

Switch Option

General	The integrated schematic switch editor extends the analyzer by the capability to interactively alter the signals. Lines can be switched, rerouted or even inverted. Data can be injected in any line (inclusive simulation of framing and parity errors). Also break conditions can be sent.
Usage	See how your application reacts when you switch a control line, interrupt the transmission and test it by sending data with a frame error or wrong parity.

W232 Cable

General	Extension of the capabilities of the RS232 analyzer MSB-RS232 by uninterrupted analysis
Benefits	Plug-in the analyzer at any time and without breaking or disturbing an active communication.

Adapter + Gender Changer

Pin wiring see right side

GCD9MD9M	Gender Changer, D-Sub.9pol. in compact size, metall case, male to male.
GCD9FD9F	Gender Changer, D-Sub.9pol. in compact size, metall case, female to female.
GCNULL	The Nullmodem Adapter converts every 1:1 wiring cable with D-Sub 9pol. connectors into a "cross switched" nullmodem configuration.
LOOPBACK	Serial RS232 loopback test plug, D-Sub.9pol. with all data and handshake linked back.
ATD9MD25F	Adapter 9 pol D-Sub male/25 pol D-Sub female, compact size.
ATD9FD25M	Adapter 9 pol D-Sub female/25 pol D-Sub male, compact size.

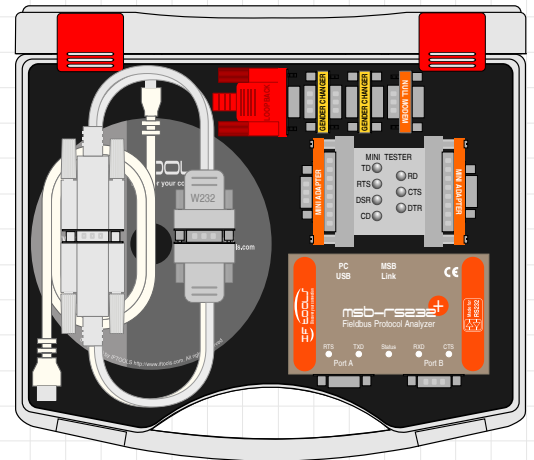

Led Tester

Description	RS232 Interface tester 9/25 pin with bicolor LEDs for the signals: TXD, RXD, RTS, CTS, DSR, DTR, DCD. Inclusive 2 gender changers 25 to 9 pin. Connection via 9 or 25 pin Dsub connector male/female.
-------------	---

Plastic case

Material	The case consists of strong and cold resistant Polypropylene (PP), one of the environmentally friendliest plastics.
Locks & Hinges	Two functional clasp prevent your case opening inopportuno and sturdy hinges ensure high stability.
Dimension & weight	255 x 210 x 48 mm (B x H x D), weight about 900g with content.

Our Price: 579 € *

Your advantage: ca. 100 €

in comparison with the single components! * Without tax

LOOPBACK

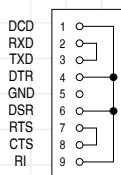

GCNULL

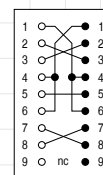

D-Sub 9 with adapters
D-Sub 25 direct
Ledtester

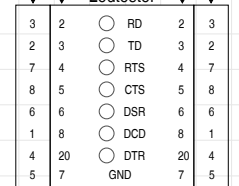

Male ● Female ○

ATD9FD25M

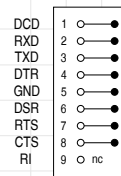

ATD9MD25F

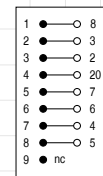

GCD9MD9M

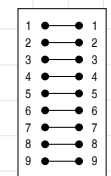

GCD9FD9F

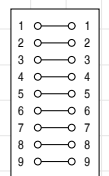

○ Female Connector ● Male Connector